

# SUBMITTAL DATA SHEET

NL Meter Setter – 720-410WCDD 44

Double Purpose X Double Purpose

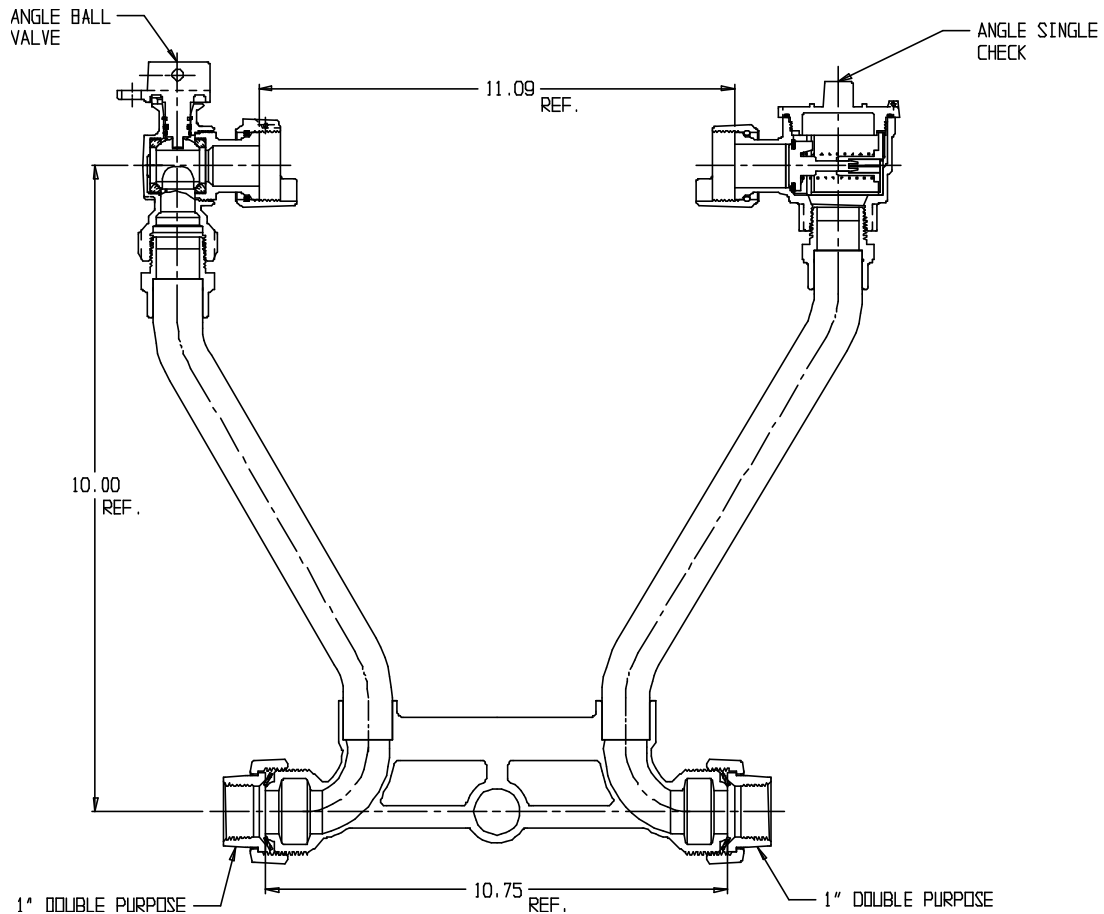

## SUBMITTAL INFORMATION

- Manufactured in compliance with ANSI/AWWA C800 (latest revision)
- Brass components in contact with potable water conform to ASTM B584, UNS C89833 (latest revision) and identified with "NL"
- Certified to NSF/ANSI 61 (reference height restrictions) and NSF/ANSI 372
- Brass components not in contact with potable water conform to ASTM B62 and ASTM B584, UNS C83600 -85-5-5-5 (latest revision)
- Copper tubing made in compliance with ASTM B75 or B88, UNS C12200 (latest revision)
- Lead free solder joints
- Designed to provide proper meter spacing for ease of installation
- Padlock wings standard on all valves



A.Y. McDonald Mfg. Co.  
4800 Chavenelle Rd  
Dubuque, IA 52002

Toll Free: 1-800-292-2737  
sales@aymcdonald.com  
[aymcdonald.com](http://aymcdonald.com)

A.Y. McDonald considers the information on this assembly drawing correct when published. Item and option availability, including specifications, are subject to change without notice.

Submitted by: