

SUBMITTAL DATA SHEET

NL Service Fitting – 74754-34

-34 PEP Compression x FNPT



MODEL	SIZE	A	B	C	D	E
74754-34	3/4	1.40	3/4	3/4	1.37	OCT
74754-34	3/4 X 1	1.40	3/4	1	1.37	OCT
74754-34	3/4 X 1 1/2	2.66	3/4	1 1/2	1.85	OCT
74754-34	1	1.75	1	1	1.69	HEX
74754-34	1 X 3/4	2.08	1	3/4	1.69	HEX
74754-34	1 X 1 1/4	2.17	1	1 1/4	2.00	OCT
74754-34	1 1/4	2.36	1 1/4	1 1/4	2.25	OCT
74754-34	1 1/4 X 1	2.66	1 1/4	1	2.10	OCT
74754-34	1 1/4 X 1 1/2	2.16	1 1/4	1 1/2	2.54	HEX
74754-34	1 1/2	2.15	1 1/2	1 1/2	2.31	OCT
74754-34	1 1/2 X 1	2.50	1 1/2	1	2.44	OCT
74754-34	2	2.86	2	2	3.13	OCT
74754-34	2 X 3/4	3.01	2	3/4	3.05	OCT
74754-34	2 X 1	3.01	2	1	3.05	OCT

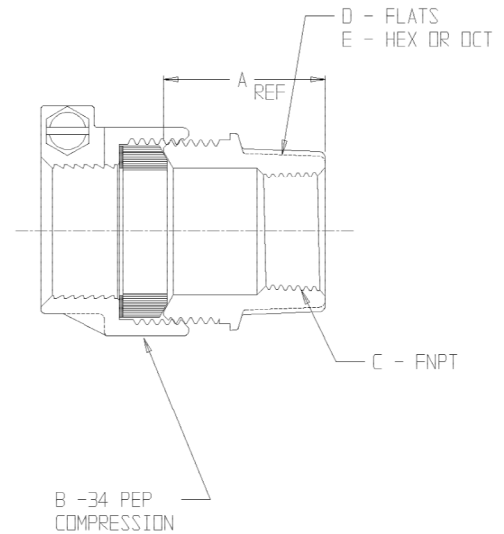

SUBMITTAL INFORMATION

- Manufactured in compliance with ANSI/AWWA C800 (latest revision)
- Brass components in contact with potable water conform to ASTM B584, UNS C89833 (latest revision) and identified with “NL”
- Certified to NSF/ANSI 61 and NSF/ANSI 372
- Brass components not in contact with potable water conform to ASTM B62 and ASTM B584, UNS C83600 -85-5-5-5 (latest revision)
- Large wrench flats provided for proper installation
- Insert stiffeners required on all flexible plastic connections



A.Y. McDonald Mfg. Co.
4800 Chavenelle Rd
Dubuque, IA 52002

Toll Free: 1-800-292-2737
sales@aymcdonald.com
aymcdonald.com

A.Y. McDonald considers the information on this assembly drawing correct when published. Item and option availability, including specifications, are subject to change without notice.

Submitted by: