

SUBMITTAL DATA SHEET

NL Ball Style Curb Stop – 76107W

FNPT x MNPT

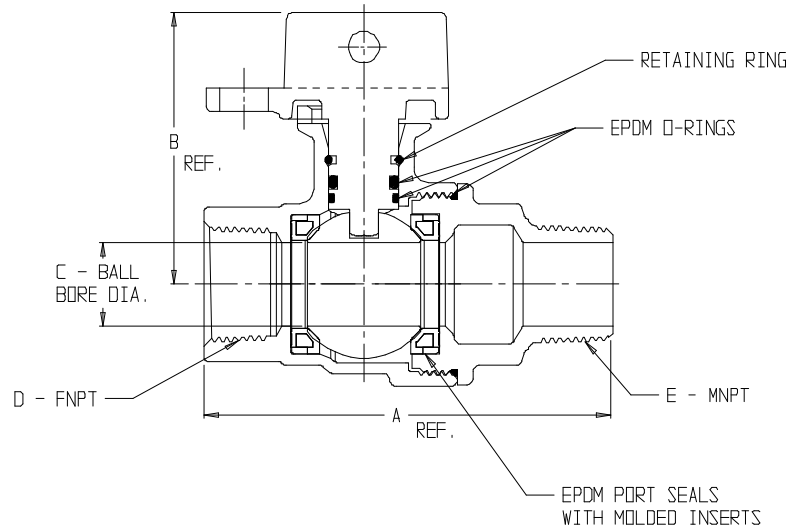

DRAWING MAY NOT RESEMBLE ACTUAL VALVE CONFIGURATION

MODEL NO.	SIZE	A	B	C	D	E
76107W	3/4 X 5/8 X 3/4	2.99	2.31	.63	3/4	3/4
76107W	3/4	3.62	2.42	.75	3/4	3/4
76107W	1	4.21	2.64	1.00	1	1
76107W	1 1/2	5.47	3.40	1.50	1 1/2	1 1/2
76107W	2	6.12	3.71	2.00	2	2

SUBMITTAL INFORMATION

- Manufactured in compliance with ANSI/AWWA C800 (latest revision)
- Brass components in contact with potable water conform to ASTM B584, UNS C89833 (latest revision) and identified with “NL”
- Certified to NSF/ANSI 61 and NSF/ANSI 372
- Brass components not in contact with potable water conform to ASTM B62 and ASTM B584, UNS C83600 -85-5-5-5 (latest revision)
- PTFE coated brass ball
- Valve rated for 300 PSIG water pressure, end connections not to exceed rated pipe pressures.
- Blow out proof EPDM port seals
- End piece joint sealed with an EPDM o-ring and thread locker



A.Y. McDonald Mfg. Co.
4800 Chavenelle Rd
Dubuque, IA 52002

Toll Free: 1-800-292-2737
sales@aymcdonald.com
aymcdonald.com

A.Y. McDonald considers the information on this assembly drawing correct when published. Item and option availability, including specifications, are subject to change without notice.

Submitted by: