

SUBMITTAL DATA SHEET

Curb Boxes – 5607LPS

Curb Box Lid Only

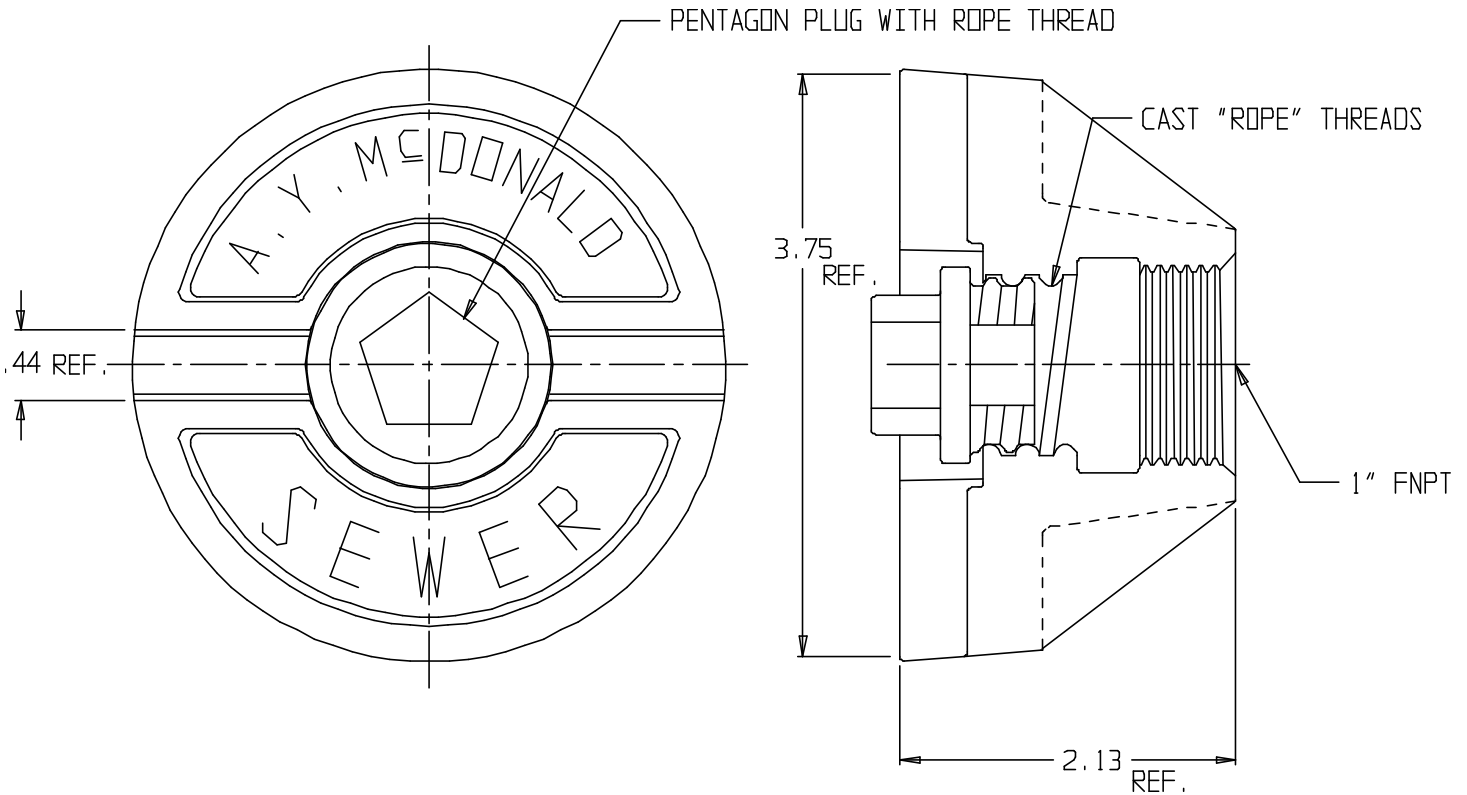

SUBMITTAL INFORMATION

- Brass components conform to ASTM B62 and ASTM B584, UNS C83600 -85-5-5-5 (latest revision) or ASTM B584, UNS C84400 -81-3-7-9 (latest revision)
- Lid made of Cast Iron per ASTM A48, Class 25
- Coated with black dip



A.Y. McDonald Mfg. Co.
4800 Chavenelle Rd
Dubuque, IA 52002

Toll Free: 1-800-292-2737
sales@aymcdonald.com
aymcdonald.com

A.Y. McDonald considers the information on this assembly drawing correct when published. Item and option availability, including specifications, are subject to change without notice.

Submitted by: